

# EM-348-SPF DC-MOTOR CONTROLLER with MODBUS

## 12-24V 15A

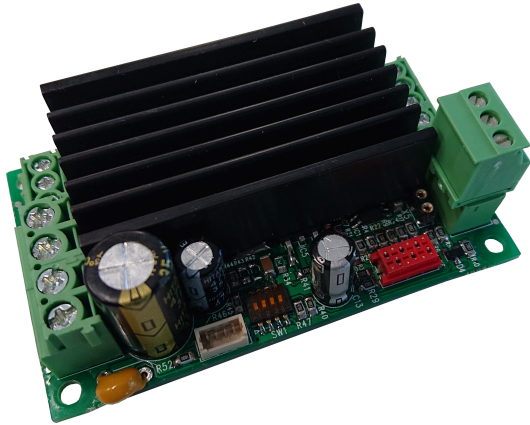

### FEATURES

- Integrated Rs-485 half duplex Bus
- Modbus RTU
- Parameter setting with Bus
- Control with Bus
- Monitoring with Bus
- High current output
- Current limit
- Position accuracy 0.2%
- Zero current trip
- Overvoltage brake
- Speed setting
- Various firmware version
- Also available low current 6A ver.
- Magnetic brake control output
- Flexible control inputs
- rail base mountable

EM-348 is a full bridge DC-motor starter. It is designed to work with DC-motor in applications where some special functions are needed. Starter has adjustable acceleration and deceleration ramps, which make possible the smooth starts and stops. Adjustable current limit protects motor against overcurrent and it can also be used as an end-stop. Driver has two selectable pwm frequency 2 or 16kHz. Power stage has smoothed switching technique which is achieved very low RF emissions, so external filter will not needed. Driver has also external brake output which can be used for control magnetic brake or braking resistor in regenerative braking.

This card has integrated Rs-485 bus, with this bus can be control and monitoring driver and also the parameter of driver can be set with bus. This interface has as a standard Modbus RTU protocol. This bus makes possible to connected several cards under one control unit. Card has also two multifunction control inputs, which can be set for digital or analog mode, depends on used firmware. This card has available with several firmware version for different applications. There is two program version for basic drive and positioning control. Card can be used with pulse or analog feedback from motor. The card has selectable input logics. Inputs are divided in two groups, control and limit /pulse -inputs. These groups can be individually set for NPN or PNP logic.

The parameter setting and monitoring can be done with Modbus or EM-236 interface unit, EM-328 with EmenTool-Lite PC-program. The Program updates domen with EmenTool

#### TECHNICAL DATA ( Pcb v1, prog EM-348-spf v1.7 )

Supply voltage cont. max. 10-35V  
 Overvoltage limit adjustable 15-40V  
 Start up voltage 9V, shutdown voltage 8V  
 Continuous current output when ambient temp is <math> < 50^{\circ}\text{C}</math>  
 15A at 100% speed / 10A at 5-99% speed pwm=2kHz  
 10A at 100% speed / 5A at 5-99% speed pwm=16kHz  
 Peak ( 5s. ) 30A at 2khz pwm and 25A at 16kHz pwm  
 Current limit adjustable 0.1-25A ( at start max 30A )  
 ( 6A version currents are typically 2.5 times smaller )  
 Overheat limit 100°C  
 Start and stop ramp adjustable 0-5s  
 PWM frequency 2kHz / 16kHz  
 Analog inputs ( pin 11 and 12 ) 0-5V or 0-10V  
 Input control logic: high =4-30V, low=0-1V  
 Control input impedances typ. 47kohm  
 Limit/pulse input ( pin 2 and 3 ) imped. typ 10kohm  
 Control input response time typ 5ms.  
 Fault out. PNP open coll. max. 50mA  
 Brake out NPN open coll max. 35V / 2A  
 Disable in active  $U_{in} > 1\text{V}$  ( NPN )  
 Bus Rs-485, two wire half duplex, 9600kb/s  
 Motor and supply connectors 2.5mm  
 Control connectors 1mm  
 Dimensions 42x72x height 25mm ( 6A version 18mm)  
 Dimensions in DIN-rail base 45x80x45mm  
 CE-tested for industrial environment ( emc )  
 Operating temp (  $T_a$  ) -40...60°C  
 Weight 75g ( 6A version 48g )

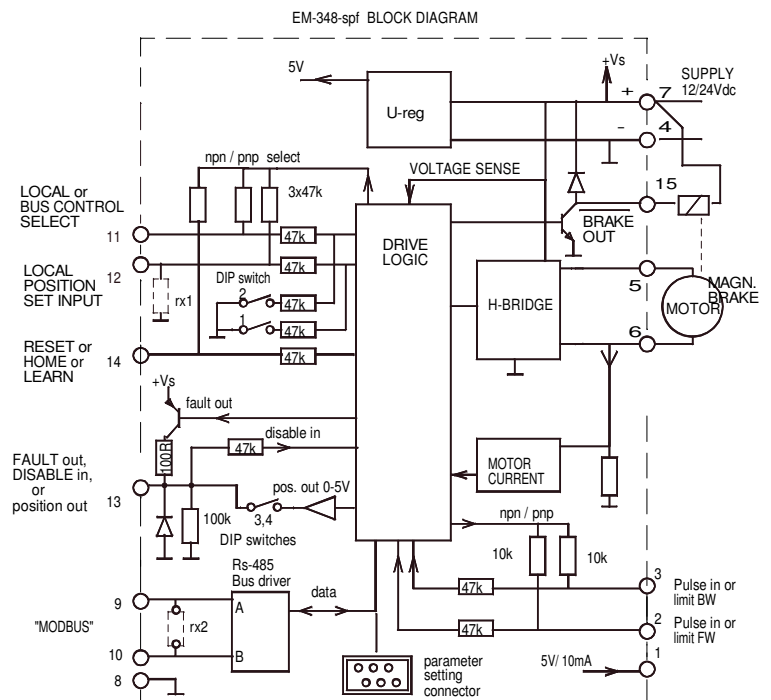

"rx" resistors are optional for special applications

**BRD. KLEE**  
 Gadagervej 11  
 DK 2620 Albertslund  
 Tlf. 43 86 83 33 - Fax 43 86 83 88  
 www.klee.dk - mail: klee@klee.dk

INGENIØR- & HANDELSAKTIESELSKAB



CONNECTION ADVICE

Supply voltage should be in the limits of 10-35Vdc. Ripple should be lower than 30% even with max. load. NOTICES !

1. Wrong supply polarity can cause damage the device.
2. There is no inbuilt fuse in this device. Use an external fuse which is chosen according to your application.
3. that function and scale of some of the input and output terminals is depending on the selected parameter values and defined ranges. Please, see the parameter list and explanations.

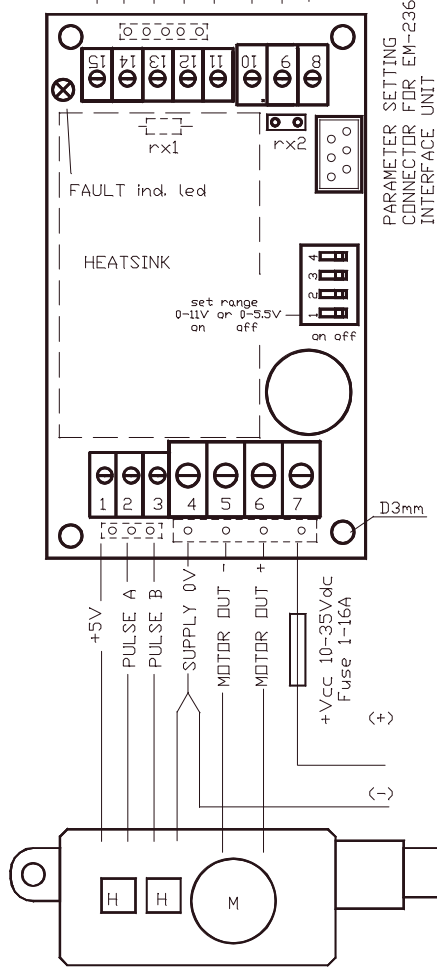
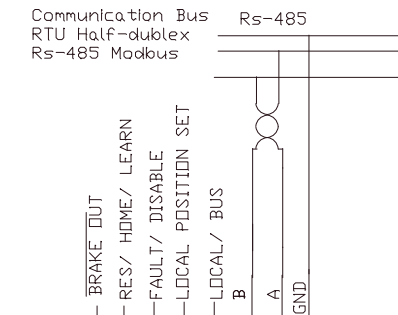

Pulse edges of 1 and 2 pulse lines

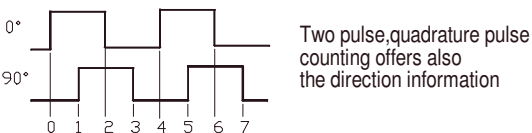

TAKING IN TO USE

The setting of the controller is done with parameters, and the parameters can be set and edited with EM-236 Interface Unit. Making changes is easy and precise. Copying the parameters to multiple units is simple and accurate. The same parameters that are saved to one unit can be copied to another unit with one push of a button. After the two first parameters have been set according to the application, the actuator and control wires can be connected and operation can be adjusted with the remaining parameters.

LOCAL / BUS ( control mode select )

This driver can be controlled with local control inputs or with Rs-485 Bus. The bus control offer more options than local inputs. NOTICE! that for Bus control has own instruction guide. The functions below are usable in both control mode. Device is set for Bus mode as default, if you want to start use local control also, then change parameter 30 to value 1 or 2

POSITION FEEDBACK ( feedback pulse inputs )

Select pulse source type 1 or 2 pulselines with parameter 1 according to your application. If possible, use always 2 pulse lines (0° and 90° phase shift) This option offer best accuracy. Select right voltage for pulses sensor. 5V and supply voltage are available. At last set the pulse inputs for NPN or PNP mode with parameter 2

FULL RANGE

Full range is the full mechanical movement of the linear motor or positioning system. At first it is always needed to determine the full range before it is possible to drive the system correctly. The full range can be determine with LEARN routine or If this number is known it can be set direct as the value of parameter 25 (Full range).

HOME RUN ( reset of position counter )

The position feedback is received as pulses so the driver can not know the right position before pulse counter is reset in some known position. Home run command will drive the motor to selected end of the full range and there it will reset the pulse edge counter. Home run is configured with parameter 14.

LEARNING ( reset position counter and measuring full range )

Learning is a special option for finding the full range and taking the system in use with out knowing the number of pulses for full range.

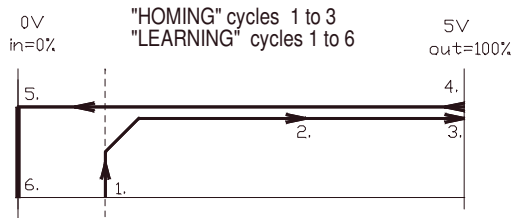

1. start learning by giving a long 5s command to RES/ HOME/ LEARN input ( pin 14)  
Notice, that parameter 14 should be set 7 to enable learn
2. motor starts to run "out" direction with learn speed
3. current limit or pulse lost stops the motor when the end is reached and position counter will be reset .  
This is also end of HOME cycle
4. motor starts to "in" direction and makes a full stroke. During stroke the pulse counter measures the range.
5. motor reaches the mechanical end "in", and current limit or pulse lost stops the motor.
6. Device stores full range value and is ready for use
7. After succesfully learning we recommended to return parameter 14 to values 1-6 ( home )

TROUBLES ON HOMING OR LEARNING

If motor run only 1-2s and then stop, normally the reason is that driver cannot read pulses or read pulses wrong. Check the voltage and logic (NPN or PNP ) of pulse sensor  
In two-pulse mode the problem could be also in pulse phasing, in other words the position counter calculate wrong direction, so interchange A and B pulse wires and try again. If you want to change home operation direction then interchange motor wires and pulse wires.

AUTO HOME

Auto home is an automated home run that is triggered during normal operation. Auto home triggering configures with par. 14 ( 3,4,5 or 6). If you choose the auto-home triggered from limit switch inputs or SW-limits, the option of using the 5seconds command to RES/ HOME/ LEARN input is also available.

## ANALOG INPUT RANGE ADJUST

Options for max. ranges are 0-5,5V, 0-11V or 0- (4) to 20mA. mA option need 250ohm resistor to the pads rx1 bottom of board. Using 0 to 11V range requires you to set the DIP switch 1 to "ON" position. Your individual control scale you can either set with parameters 21 and 22 as Volts or you can let the driver to measure your min. and max. cont. values. If you choose to set the min. and max. as Volts, pls. notice that the values are in ratio to the lowest range 0-5,5V, and with 0-11V range you must divide the actual voltage with two. With current signal the right value is  $I \times 250$ . Eg:  $4-20mA = 1,0 - 5,0V$ . Most accurate way is to let the driver to measure the values. So first connect and adjust minimum value to set input (pin.12) and change the par.21 to val. 551, after value stops blinking the display shows the measured value. Then adjust the maximum control value to pin.12, and change par.22 to 551.

### Example for INPUT RANGE and MECHANICAL RANGE ADJUST

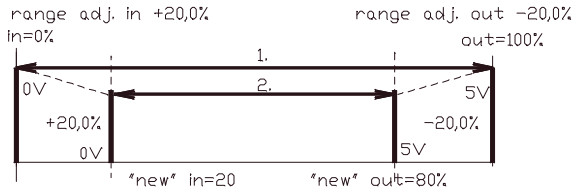

1. Original learned range = mechanical full range  
control signal range is 0-5,0V  
set parameter 20=0 and 21 = 500
2. Desired mechanical range compression for both end 20%  
inner end = +20,0% set parameter 23 = 200  
outer end = -20,0% set parameter 24 = 200  
"New" stroke of actuator is compressed to:  
positioning set value 0V = 20,0% position  
positioning set value 5V = 80,0% position

## POSITIONING DYNAMIC

Dead zone (par.17) is to determine the accuracy of positioning. This parameter has the major effect to positioning accuracy. The smaller it is determined the more accurately the positioning is done. Notice. If it is set too small compared to accuracy level of the mechanics an oscillation or instability in positioning will occur.

Braking area (par. 18) is used to optimize the time needed for positioning. Too high value slows down too early, and too low value will cause a fast position passing and needs a corrective return driving.

Start and stop ramp (par. 19 & 20) are to smoothen the direction change. Often suitable value for stop ramp is half of start ramp. Too long stop ramp can make the direction change too time consuming and too short can cause mechanical stress and non desired aggressivity.

### POSITIONING WINDOW

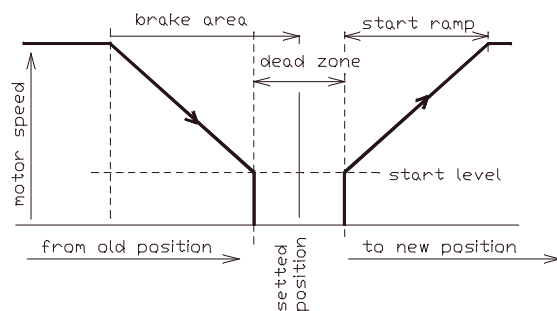

## LOAD COMPENSATION ( torque at low speed )

Load compensation (par.11) when set to right value, will ensure the needed force to start driving and to taking the load in to the right position. With high load and too low load compensation value, the motor don't have force enough to reach the right position. Start testing with zero value and increase value until motor behaves unstable and twitching. Thumb rule in this point is to decrease the value with 25%.

## CURRENT LIMIT and TRIP

Current limits should be set according to the motor nominal max. current or according to the required current of the application. I-trip ( overcurrent shutdown ) delay can be adjusted with param. 8

## CONTROL INPUTS AND OUTPUTS.

### Rs-485

Standard half-duplex Rs-485 terminal incl. gnd, A and B. The line terminal resistor 120R can be set to socket Rx2 if needed.

### LOCAL / BUS ( optionally BW end limit )

This input is for LOCAL or BUS control mode selection. The configuration of pin can be done with parameter 30, The parameter options 1 and 2 activates this pin for control mode selection. the LOCAL control is default at value 1 and the BUS control is default at value 2. ( default = pin is free ) The control signal to this pin will change the control mode. Also if this pin is set to control mode selection use, then it has highest priority and it cannot overrun with BUS. The parameter choice 0 set this input to work as BW end stop limit input, and then the LOCAL / BUS selection can be done only through via BUS.

### POSITION set

this is analog input. for local mode position setting. This input range is 0-5.5V or 0-11V, which select DIP-switch 1. This input can be use 0-4-20mA input also, if adds 250ohm shunt resistor rx1 in bottom side place

### FAULT out / DISABLE in ( optionally position. out )

This terminal is normally NPN fault indication output, but it works same time as DISABLE in if externally activates. This terminal has also special mode, position out, when it gives analog signal, see param. 9 and DIP-sw. 3 and 4

### RES/ HOME /LEARN

At short command this input reset fault, and with longer 5s command this input starts HOME or LEARN cycles. See parameter 14.

### BRAKE OUT

This NPN output can be used to control magnetic brake of motor or as a braking resistor in re-generation situation see. parameter 27

## INDICATIONS

Fault situations are indicated with coded blinking of the red LED. and fault code number is also read from monitor value.

Combiport (pin.13). indicated fault situations also. This output pull up in fault situation as, overtemp, I-trip, pulse lost etc. If combiport is set to work as position output then fault indications gives with voltage level, see parameter 9

## RESETTING OF FAULTS

The faults can be reset with short command to RES./HOME/LEARN input. I-trip and pulse lost faults reset also automatically if gives new position set which starts run to opposite direction. Faults can be reset also via bus, if bus mode is selected.

## PARAMETERS prog. EM-348-spf v1.7 (defaults in bracket )

- 1 Feed-back mode : one-pulse=1, dual-pulse=2 ( 2 )
- 2 Limit and pulse input logic ( 2 )
  - 1= limit inputs PNP / pulse inputs PNP
  - 2= limit inputs PNP / pulse inputs NPN
  - 3= limit inputs PNP inverted / pulse inputs PNP
  - 4= limit inputs PNP inverted / pulse inputs NPN
- 3 Speed FW: 20-100% / 0-100 ( 100 )
- 4 Speed BW: 20-100% / 0-100 ( 100 )
- 5 Speed HOME/LEARN: 20-100% / 20-100 ( 60 )
- 6 Current limit out, FW: 0.1-20A / 1-200 ( 20 )
- 7 Current limit in, BW: 0.1-20A / 1-200 ( 20 )
- 8 Current trip delay: 0-255ms / 0-255 ( 100 )  
(0 = tripp not in use)
- 9 FAULT / DISABLE (pin 13) function: 1-4 ( 3 )
  - 1= used as Fault out / Disable in (fault/dis=0V)
  - 2= gives the "positioned" data (positioned=0V)
  - 3= gives position info out with 0-5V
  - 4= gives position info with 0.5-4.5V and fault =0V
- 10 Over voltage limit: 15-40V / 15-40 ( 35 )
- 11 Load compensation: 0-255 / 0-255 ( 0 )
- 12 Time out: 1-255s. / 1-255 (0= not in use) ( 0 )
- 13 Hour and start counter reset ( 0 )  
set value = 1 and press SAVE -> hour and start counter reset
- 14 Home run / learn function: 1-7 ( 7 )
  - 1= Home run with RES / LEARN input to BW direction ( >5s. comm. )
  - 2= Home run with RES / LEARN input to FW direction ( >5s. comm. )
  - 3= Auto-Home from BW LIMIT input to BW direction ( pin 9 )
  - 4= Auto-Home from FW LIMIT input to FW direction ( pin 10 )
  - 5= Auto-Home triggered with inner soft limit to BW direction
  - 6= Auto-Home triggered with outer soft limit to FW direction
  - 7= Learn routine with >5s command to RES /LEARN input (pin.11)
- 15 Not in use ( 0 )
- 16 Not in use ( 0 )
- 17 Dead zone : 0,2-5% / 2-50 ( 10 )
- 18 Braking zone : 1-8% / 1-8 ( 3 )
- 19 Start ramp : 0.1-2.5s / 0-25 ( 3 )
- 20 Stop ramp : 0.1-2.5s / 0-25 ( 3 )
- 21 Set value min: 0...5.50V / 0-551 (0)
- 22 Set value max: 0...5.50V / 0-551 (550)  
For parameters 21 and 22 value 551 will do an auto setting
- 23 Inner (BW) SW-limit: 0...+50% / 0-500 ( 2 )
- 24 Outer (FW) SW-limit: 0...-50% / 0-500 ( 2 )
- 25 Full range (pulse edges) 100-65535 / 100-65535 ( 1000 )
- 26 Pwm frequency 1 = 2kHz and 2 = 16kHz
- 27 Brake output options ( 1 )
  - 1= output activates in overvoltage situation
  - 2= output activates when run, this is for releasing magnetic brake
- 28 Serial line configuration, speed, parity, and number of stop bits ( 1 )
  - 1 =9600bps 8N1 5 =19200bps 8N1
  - 2 =9600bps 8N2 6 =19200bps 8N2
  - 3 =9600bps 8E1 7 =19200bps 8E1
  - 4 =9600bps 8O1 8 =19200bps 8O1
- 29 Modbus address 1-247 ( 1 )
- 30 LOCAL / BUS input ( pin 11 ) ( 0 )
  - 0 = pin 11 is BW end switch, local/bus selection only with BUS
  - 1 = pin 11 defines control mode local/bus, pin open=LOCAL
  - 2 = pin 11 defines control mode local/bus, pin open=BUS

### FAULT LED - blinking codes

- |                               |         |
|-------------------------------|---------|
| 1. I-trip                     | 1 blink |
| 2. pulse lost                 | 2 blink |
| 3. over temperature           | 3 blink |
| 4. over voltage               | 4 blink |
| 5. time-out trip              | 5 blink |
| 6. learn corrupted            | 6 blink |
| 7. bus communication time-out | 7 blink |
| 8. homing in progress         | 8-blink |
| 9. homing in progress         | 9-blink |

### MONITORABLE VALUES ( Can be read with EM-236)

- 1 fault code ( see above ) 1-9
- 2 motor current 0-20A / 0-200
- 3 target position 0-100,0% (0-1000)
- 4 realized position 0-100,0% (0-1000)
- 5 position as pulse edges 0-65535
- 6 hour counter (max.65535h)
- 7 start counter (max.65535)
- 8 start counters over flow counter (max. 65535)

## ADJUSTMENT AND SETTINGS ( prog ver. EM-348-spf v1.7 )

Settings can be done with three interface device options.

1. EM-236A interface unit
2. EM-328 series interface units with EmenTool Lite PC-software

### ABOUT PARAMETERS

1. Feedback mode is a mandatory setting to be done according to the application. 1= for one pulse line only, 2= two pulse lines for 0° and 90° pulses.
2. Limit and pulse inputs (pins 9, 10, 2 and 3) can be set to work with positive or negative logic. Signal can be either pulling up =PNP or down to 0V which is often marked as NPN signal.
- 3 & 4 driving speed to FW (out) and BW (in) directions.
- 5 The speed setting for "home run" and "learn" routines.
- 6 & 7 Current limit setting for FW (out) and BW (in) driving directions.
- 8 Current tripp delay time 1-255ms, if set to 0 the tripp is disabled
- 9 Fault/Disable i/o (pin 13). This terminal can work as combined input-output. It can be fault output and disable input or an on position indicator giving an "positioned" signal after a successful positioning. It can also be used to indicate the position with continuous voltage signal 0-5V (val.3) or 0,5-4,5V + 0V fault (val.4).  
Notice: With val. 3 or 4, also the DIP3 must be set to "ON" position.
- 10 Over voltage limit. Motor is switched to free wheel if the selected voltage level is exceeded. This saves the driver or other devices in supply line from over voltages in case the motor generates surplus energy during slow down or braking.  
This can happen eg. in vehicle or lifting applications.
- 11 Load compensation (Rxl-comp) ensures good torque with low speeds. It is good to start testing with zero value, but if the motor seems weak when starting or slowing down to the right position this value can be increased carefully and step by step.  
Notice: Too high value is recognized from oscillation and/or twitching.
- 12 Time out tripp will cut off the driving if continuous driving to the same direction exceeds the set value (statet in seconds).
- 13 Usage counter reset parameter is for manual reset of counters. Choosing and saving value 1 will reset the hour and start counters.
- 14 Home run direction and start condition setting or enabling the learn routine for finding the full movement range.  
Home run can allways be started with RES/LEARN input (pin 11). Auto home can be started with actual limit switch inputs or with so called SW-limits (par. 23 and 24). Last special option (value 7) is for starting the learn routine. That is an end to end drive routine to count and determine the real full movement range.
- 15 Not in use in this program version.
- 16 Not in use in this program version.
- 17 Dead zone is for determining the suitable positioning accuracy. If this positioning window value is small the positioning is tended to be done more accurately. If value is too small compared to the accuracy of the other parts of the application, the system might not be able to work properly. Notice. Other parameters like braking zone and FW/BW speed settings will also affect to the positioning behaviour.
- 18 Braking zone value is determined as a percentage of the full movement range. It determines how early driver starts to slow down before reaching the right position. Main rule is that small value for slow applications and high value for fast applications.
- 19 & 20 Start and stop ramps are used to smoothen the speed and direction changes. Its the time from 0-100% or from 100%-0 speed.
- 21 & 22 are for determining the control signal range limits. Value can be given as Volts, 0 to 550 (0 to 5,5V), or the min. and max. values can be measured automatically by setting value to 551.  
Then the card will measure the signal in the POSITION SET input. Pls. read also the chapter "Control range setting".
- 23 & 24 Inner (BW) and outer (FW) SW-limits. With these adjustable limits the movement range can be limited to suite the application.  
Notice: if either of these SW-limits is used for auto-home (par.14) the motor will drive over the limit when executing the home run.
- 25 The full-range is determined by setting the known or calculated full range pulse edge count to be the parameter value. Alternatively the value can be defined by making the learn run (par.14 val.7)  
Notice. The learned pulse edge number is up dated to the EM-236 Interface unit display when you make a new Load & Edit data query or try to change the value right after learn routine.
- 26 Power stage PWM freq. 16kHz is quiet, 2kHz offer better efficiency
- 27 Brake output configuration parameter.
- 28 Bus freq. parity and stop bits setting
- 29 Modbus address
- 30 Local / Bus input configuration.